

sapa:

Elegance

Curtain walling

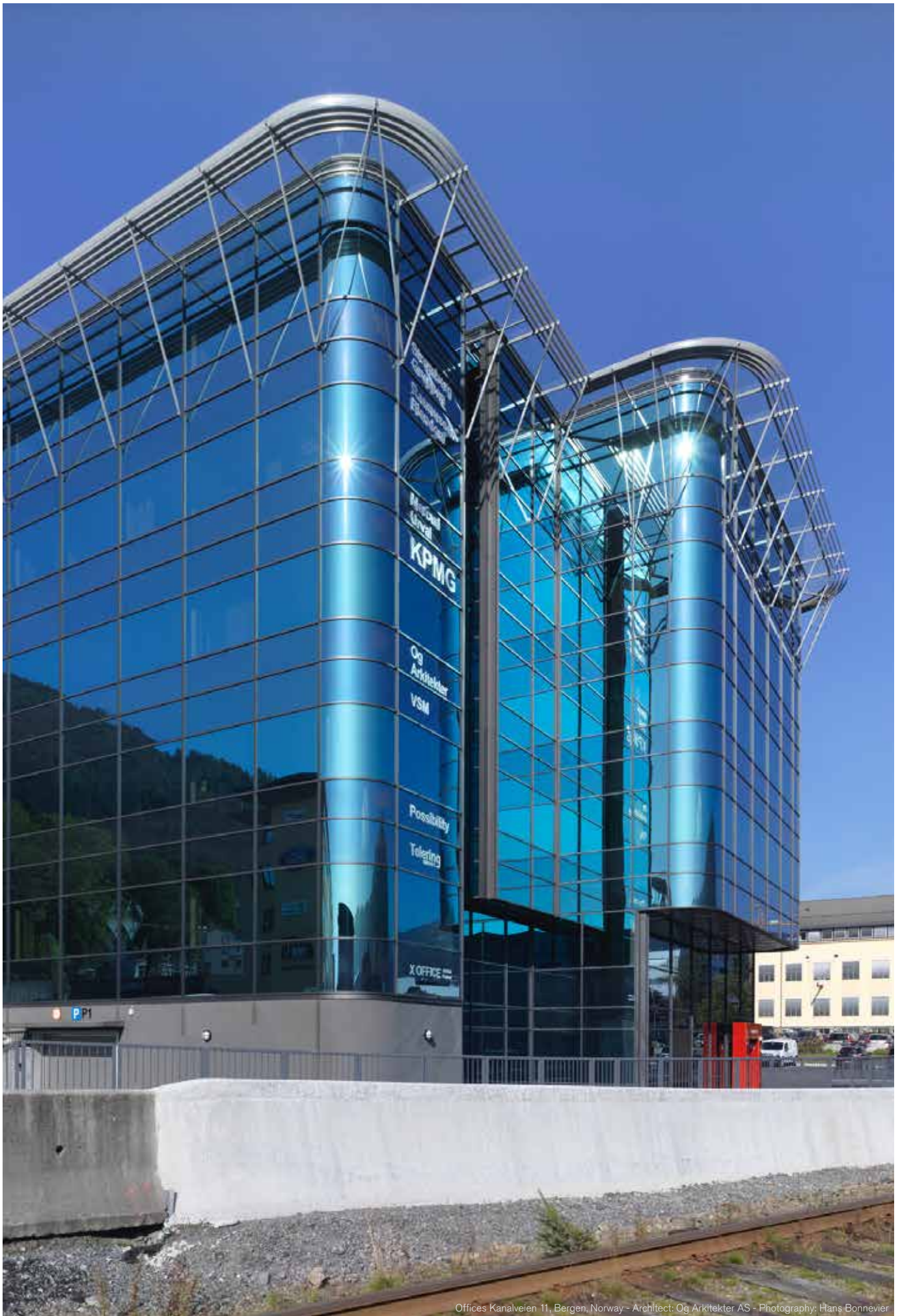



Offices Kanalveien 11, Bergen, Norway - Architect: Og Arkitektur AS - Photography: Hans Bonnevier

Elegance 52

Curtain Walling

Conceived more than 25 years ago, the Elegance curtain wall portfolio has matured into a comprehensive façade system that combines technology and design with the demands of contemporary building construction.

Stick systems

Elegance 52 ST	fully capped	5
Elegance 52 HL/VL	semi capped	7
Elegance 52 Roof	sloped glazing	9
Elegance 52 IN	industrial look	11
Elegance 52 SX	structurally clamped	13
Elegance 52 SGC	structurally clamped	15

Specialist stick systems

Elegance 52 PV	photovoltaic	17
Elegance 52 FR	fire rated	19
Elegance 85 PF	blast resistant	21

Integrated windows

Elegance 52 IT	structurally glazed, with glazing bead	23
----------------	--	----

Semi unitised

Elegance 52/85 GF	beaded frames	25
Elegance 52/85 SG	structurally glazed	27

Unitised

Elegance 72	project solutions	29
-------------	-------------------	----

Solar shading

Elegance SC	solar control	31
-------------	---------------	----



AZ Damaan Hospital, Oostende, Belgium - Architect: Boeckx Architecture & Engineering - Photography: Hans Couckuyt

Elegance 52 ST

Capped curtain walling

Elegance 52 ST is anything but standard, with a proven history for performance and thermal insulation, solutions range from cold single glazing to high performance achieving the requirements of Passive House certification from IFT Rosenheim.

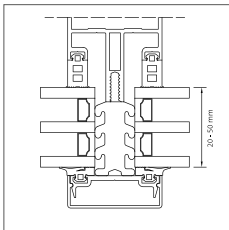

Elegance 52 SHI Super High Insulated

- Thermal performance according to “passive house” standards.
- $U_m, U_t = 0,94 - 1,0 \text{ W/m}^2\text{K}$
- PE-insulator (concept Foam-Power®) with a depth of 36 mm

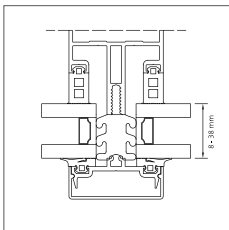

Elegance 52 SI Super Insulated

- $U_m, U_t = 1,1 - 1,5 \text{ W/m}^2\text{K}$
- PE-insulator (concept Foam-Power®) with a depth of 24 mm

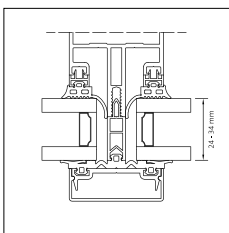

Elegance 52 I Insulated

- $U_m, U_t = 2,1 - 2,5 \text{ W/m}^2\text{K}$
- Improved thermal glazing gaskets

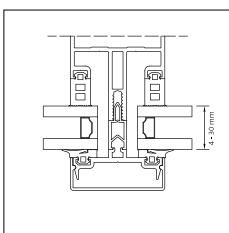

Elegance 52 basic

- $U_m, U_t = 2,8 - 3,5 \text{ W/m}^2\text{K}$

- Four drainage level profiles are available for intricate fenestrations
- Drainage can be both pane / field / compartmental, or via the mullion.
- A comprehensive range of profiles assure an optimised inertia for horizontal and vertical spans
- All transoms can be front loaded thanks to an innovative spring support cleat.
- Extensive range of cover caps to create an endless array of external appearances
- Dry glazing is achieved using EPDM internal glazing gaskets.
- All window and door systems from the SAPA product range can be easily integrated.
- Punch tools and drill jigs ensure accurate and fast pre-fabrication of all connection, drainage and aeration preparations.

Weather performance

Airtightness	A4
Watertightness	RE1200
Wind resistance	3000
CWCT	Test sequence B
Impact resistance	I5 / E5

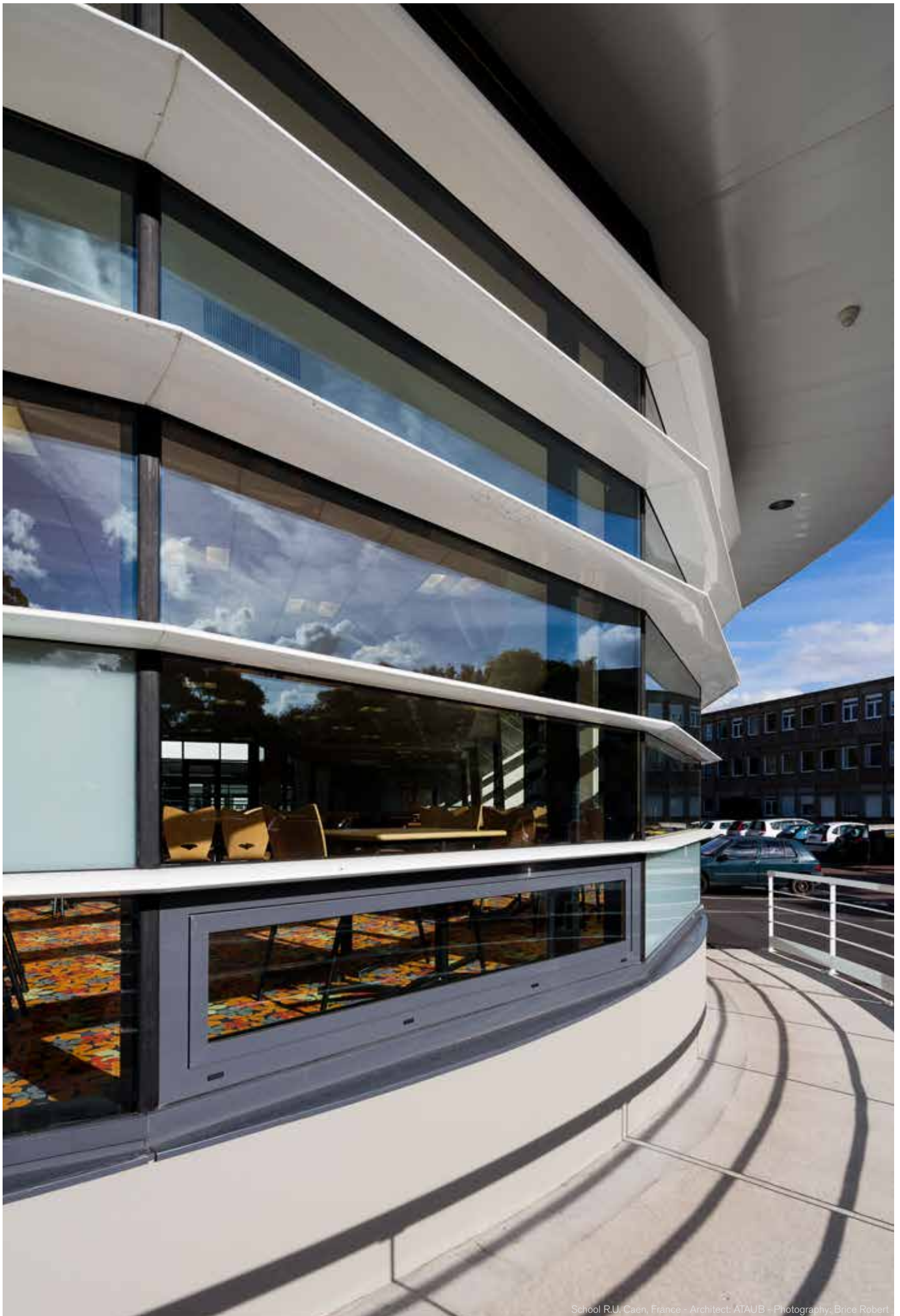

School R.U. Caen, France - Architect: ATaub - Photography: Brice Robert

Elegance 52 HL / VL

Semi capped curtain walling

Elegance 52 HL/VL solutions create an external emphasis on the horizontal or vertical aspect, by minimising the glass-to-glass visual of the adjacent line.

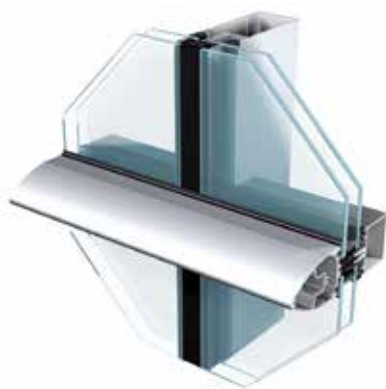

Horizontal lining



Vertical lining

- Based on the connection and drainage principles of Elegance 52 ST, the Elegance 52 HL/VL solutions are available in 2 different forms.
- Each provide emphasis on the horizontal line (HL) or vertical line (VL) by use of projecting feature caps that can be further accentuated by colour.
- The first form uses a silicone seal to minimise the joint between glass panes on the adjacent line, with an EPDM thermal break that doubles as a bond breaker.
- The second uses a dry gasket for a consistent external aesthetic, in conjunction with standard thermal break profiles from the Elegance 52 ST system

- Depending on the glass pane dimensions and external wind loads, safety pieces may be required to ensure the glass is adequately sealed against the backed structure on the non-emphasised line where there is no pressure plate or cover cap.

Weather performance

Airtightness	A4
Watertightness	RE1200
Wind resistance	3000



Elegance 52 Roof applications

Sloped curtain walling

Elegance 52 Roof utilises the main profiles from the Elegance 52 system to create a variety of sloped glazing constructions.



- With over-lapping connections and four drainage level profiles, the Elegance 52 system is perfect for sloped applications.
- Any water that may penetrate the outer seals is safely evacuated via the mullion drainage channels to an eaves level outlet or a connected vertical facade.
- Low profile cover caps allow water to efficiently flow over the external surface of the curtain wall.
- A range of gutter solutions provide a seamless integration between the sloped glazing and the vertical facade.
- Optional opening roof lights can provide effective natural smoke and heat ventilation.
- These are fitted with motors, with the combination tested and certified according to EN 12101-2:2003.

System performance

Airtightness	AE1200
Watertightness	RE1200
Impact resistance	SB1200



College, Hull, United Kingdom - Architect: DLA Architecture Ltd - Photography: Andrew Wright

Elegance 52 IN

Industrial-look curtain walling

Elegance 52 IN is a project based system using I and T shaped profiles inside and out create an industrial feel to the curtain wall.

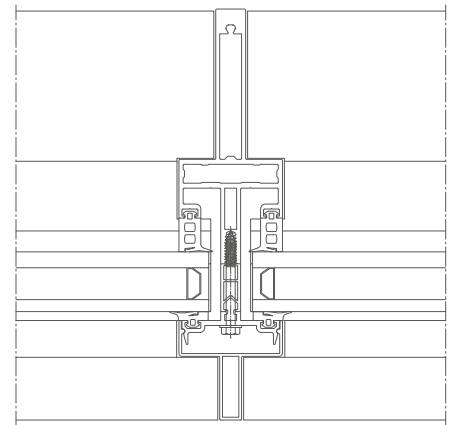
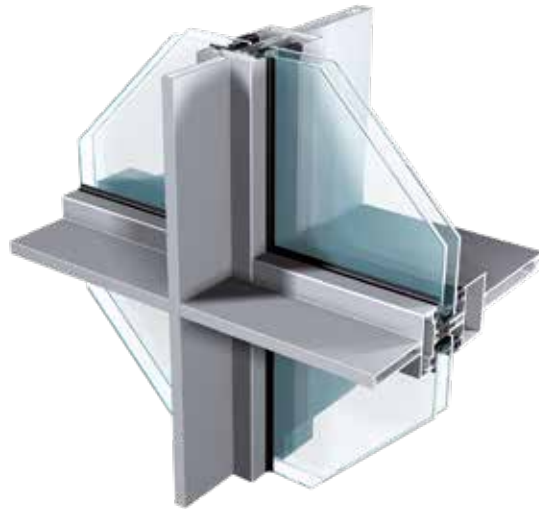

- The Elegance 52 IN system is an extension of the Elegance 52 ST, using the same connection and drainage principles.
- The difference being, where the Elegance 52 ST system consists of tubular mullion and transom profiles, the Elegance 52 IN system uses a range of I and T shaped mullion and transom profiles, to create a slender interior design effect.
- The appearance can be continued externally with similarly shaped cover caps.
- Complimentary anchoring and movement solutions are also available to complete the look.

System performance

Airtightness	AE750
Watertightness	RE750
Wind resistance	3000
Impact resistance	I5 / E5

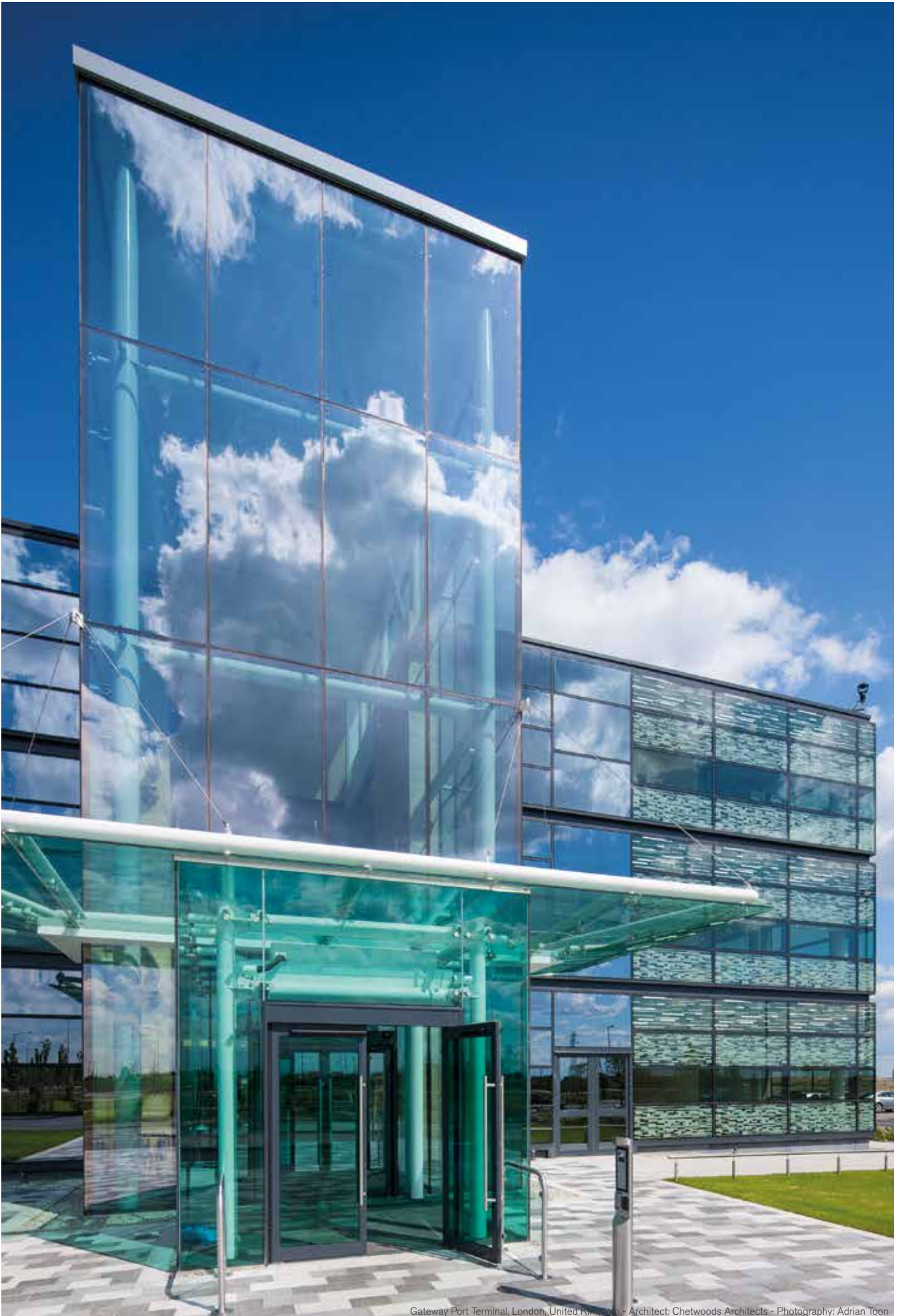

Gateway Port Terminal, London, United Kingdom - Architect: Chetwoods Architects - Photography: Adrian Toon

Elegance 52 SX

Continuous structurally clamped curtain walling

Elegance 52 SX provides a low cost alternative to full structural silicone glazing, creating a flush glazed appearance using concealed pressure plates.

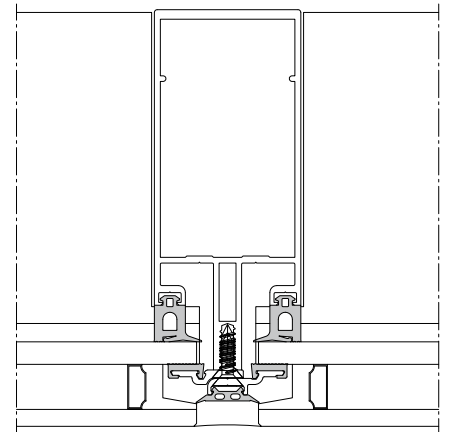

School, Gent, Belgium - Architect: ABSCIS ontwerpgroep - Photography: Hans Couckuyt

- Based on the connection and mullion drainage principles of Elegance 52 ST, the Elegance 52 SX solution uses specialist double glazed units with a silicone seal between adjacent panes for a flush glazed appearance.
- The outer-pane of the double glazed unit is structurally bonded to the inner pane, and a continuous system specific void is formed around the perimeter to create an area into which continuous half pressure plates can be manoeuvred and secured directly to the nosing of the mullions and transoms.
- Once installed, the half pressure plates form a complete continuous clamp on the inner pane of the unit, securing and sealing it to the curtain wall.
- This solution provides an economic alternative to traditional structural glazed curtain walls, creating a flush surface appearance.
- Where openings are required, the Elegance 52 IT NS window can be seamlessly integrated.

System performance

Airtightness	A4
Watertightness	R7
Wind resistance	900
Impact resistance	I5 / E5



Palladium Tower, Istanbul, Turkey - Architect: SHoP Architects - Photography: Hans Couckuyt

Elegance 52 SGC

Intermittently structurally clamped curtain walling

Elegance 52 SGC offers a thermal enhancement to the SX solution and a low cost alternative to full structural silicone glazing, creating a flush glazed appearance using concealed toggles.

- Based on the connection and mullion drainage principles of Elegance 52 ST, the Elegance 52 SGC solution uses specialist double and triple glazed units with a silicone seal between adjacent panes for a flush glazed appearance.
- The double or triple glazed units of Elegance 52 SGC are retained using single or double concealed toggle brackets.
- The double and triple glazed units incorporate an intermittent and system specific channel profile around the perimeter, into which the toggle brackets are located and secured directly into the nosing of the mullion and transom profiles.
- This solution provides a highly thermal and economic alternative to traditional structurally glazed curtain walls, creating a flush surface appearance.
- Where openings are required, the Elegance 52 IT NS window can be seamlessly integrated.



System performance

Airtightness	AE1800
Watertightness	RE1800
Wind resistance	2000
Impact resistance	I5 / E5

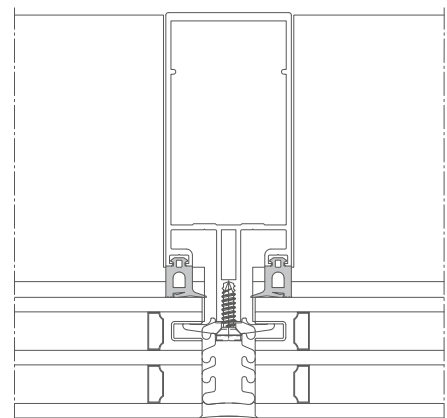

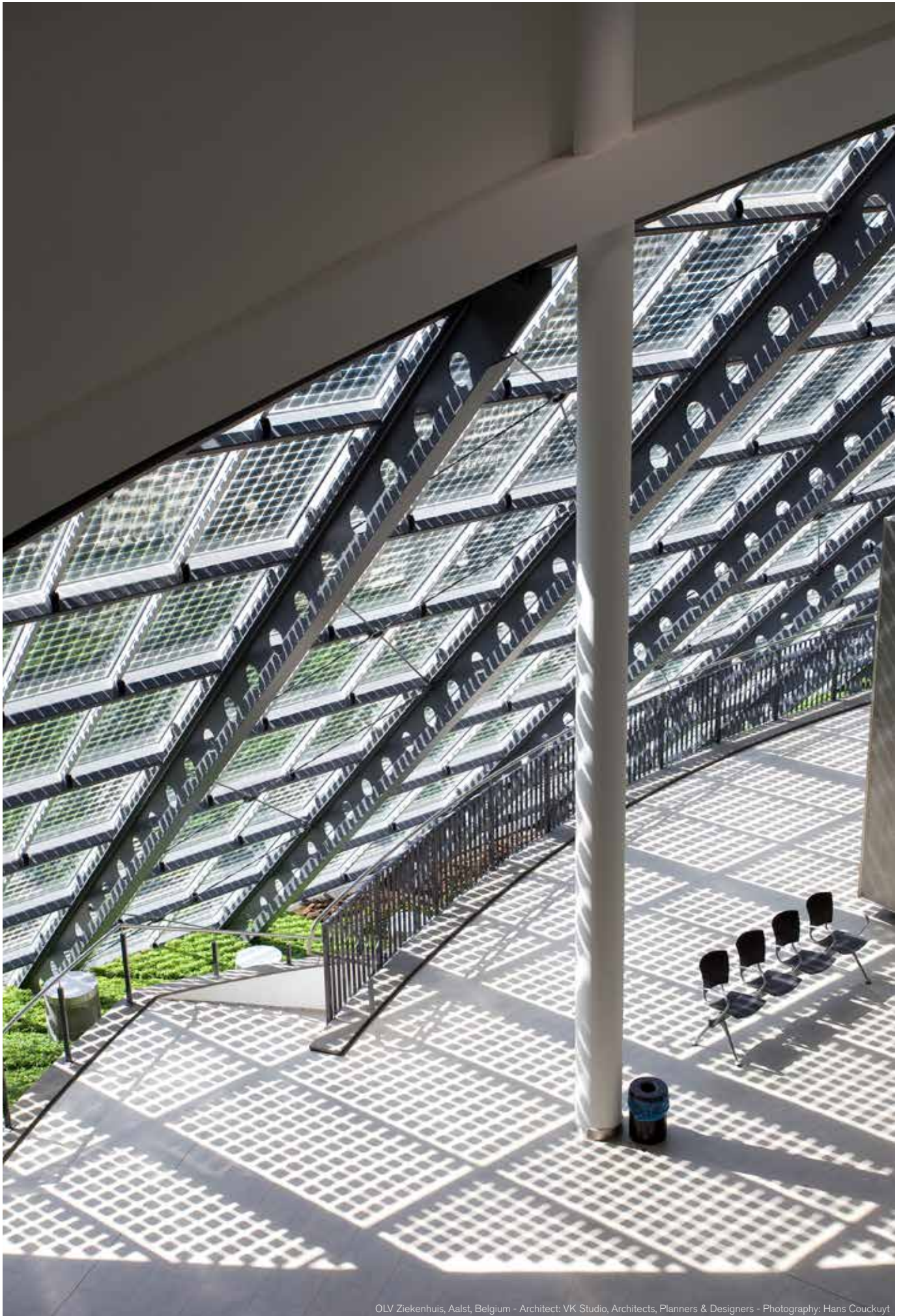

OLV Ziekenhuis, Aalst, Belgium - Architect: VK Studio, Architects, Planners & Designers - Photography: Hans Couckuyt

Elegance BIPV

Building integrated photovoltaics

Elegance BIPV is the complete photovoltaic system for the building envelope.



What are Building Integrated Photovoltaics ?

- While standard PV solutions are often used in residential applications, BIPV provides the architect with new possibilities to incorporate solar technology into buildings.
- Our building integrated photovoltaic modules create a world of possibilities. The wide variety of elegant forms, colours and optical structures of cells, glass and profiles enables creativity and a modern approach to architectural design.
- It allows specifiers to deliver an energy-efficient, innovative and prestigious project and to set new architectural standards for the future by combining elegance and function.
- PV modules can be incorporated into the building vertically, horizontally or at an angle.
- The modules can be tailor-made in accordance with dimensions and customer wishes. A selection of cells and positioning can be adapted according to project design specifics: transparency, light control, module design, shading, dimension.

System performance

Airtightness	AE750
Watertightness	RE750
Wind resistance	3000
Impact resistance	I5 / E5

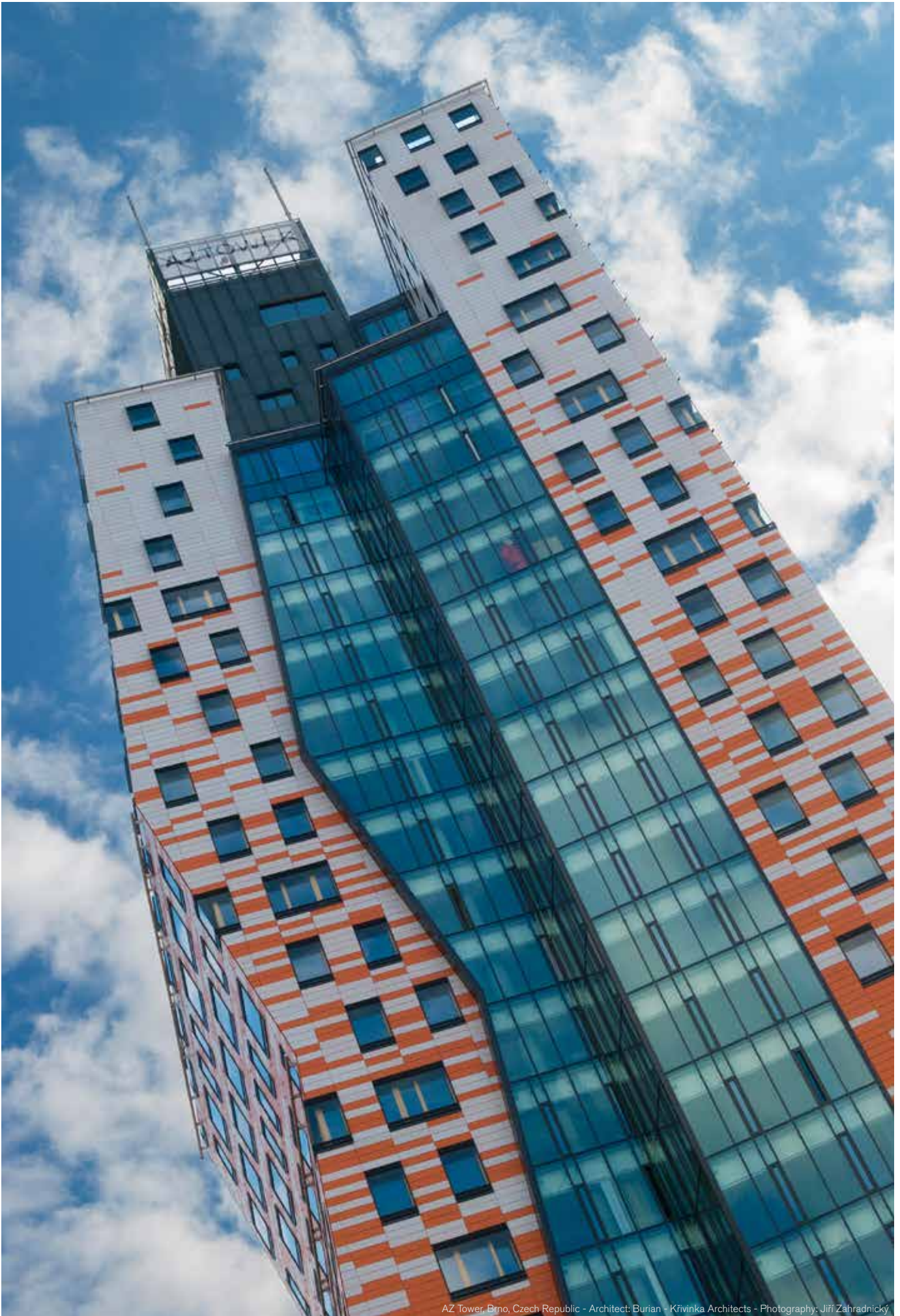

AZ Tower, Brno, Czech Republic - Architect: Burian - Kivinka Architects - Photography: Jiří Zahradnický

Elegance 52 FR

Fire rated curtain walling

Elegance 52 FR has been designed to meet the demand for the protection of people and their possessions in and around buildings.

- Based on the connection, drainage, clamping and capping principles of Elegance 52 ST, the Elegance FR solution is indistinguishable therefore providing continuity of appearance with non-fire rated elements, and affording the mixing of both solutions where partial compartmentation is required.
- A combination of intumescent strips, steel pressure plate clips, cooling materials and fire resistant glazing ensures EI 30 classification.
- Both integrity and insulation are provided by the system, which as a result means not only the fire itself, but also heat is kept outside for at least 30 minutes.
- Elegance 52 FR has been officially tested to EN 1364-3, EN 1363-1 and EN 1363-2 for both internal and external fire-exposure.
- It is clear that any adaptation to create fire resistance within the curtain wall will increase both the value and safety of the project.

System performance

Airtightness	AE750
Watertightness	RE750
Wind resistance	3000
Impact resistance	I5 / E5
Fire resistance	EI 30

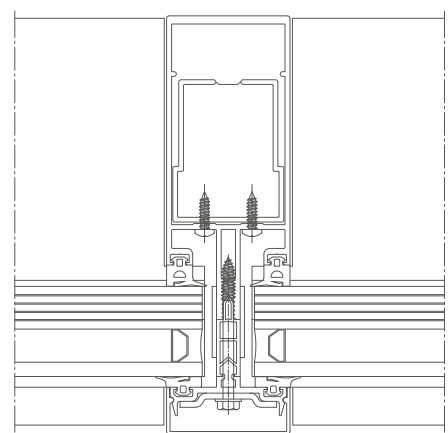



Elegance 85 PF

Blast resistant curtain walling

Elegance 85 PF is a curtain wall system that provides protection in the event of a blast incident.

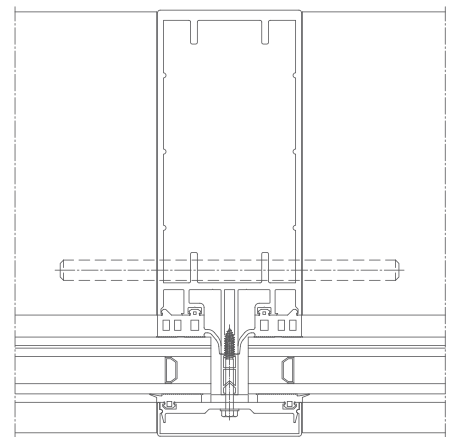

- Utilising the core and weathering principles of Elegance 52 ST, the Elegance 85 PF system has been designed specifically for the purpose of blast resistance.
- It derives the maximum benefit from the membrane action of laminated glass and its ability to safely transmit complex loads to the perimeter fixings, via the frame profiles.
- 30 mm deep glass rebates ensure that the glass is securely retained within the frame to provide a safe barrier for the building's occupants and contents.
- Complimentary windows and doors are also available in the SAPA Powerframe range, and can be incorporated into the curtain wall facade for a complete blast resistant solution.
- Products have been tested in accordance with ISO 16933 EXV25.

System performance

Blast resistance

EXV25

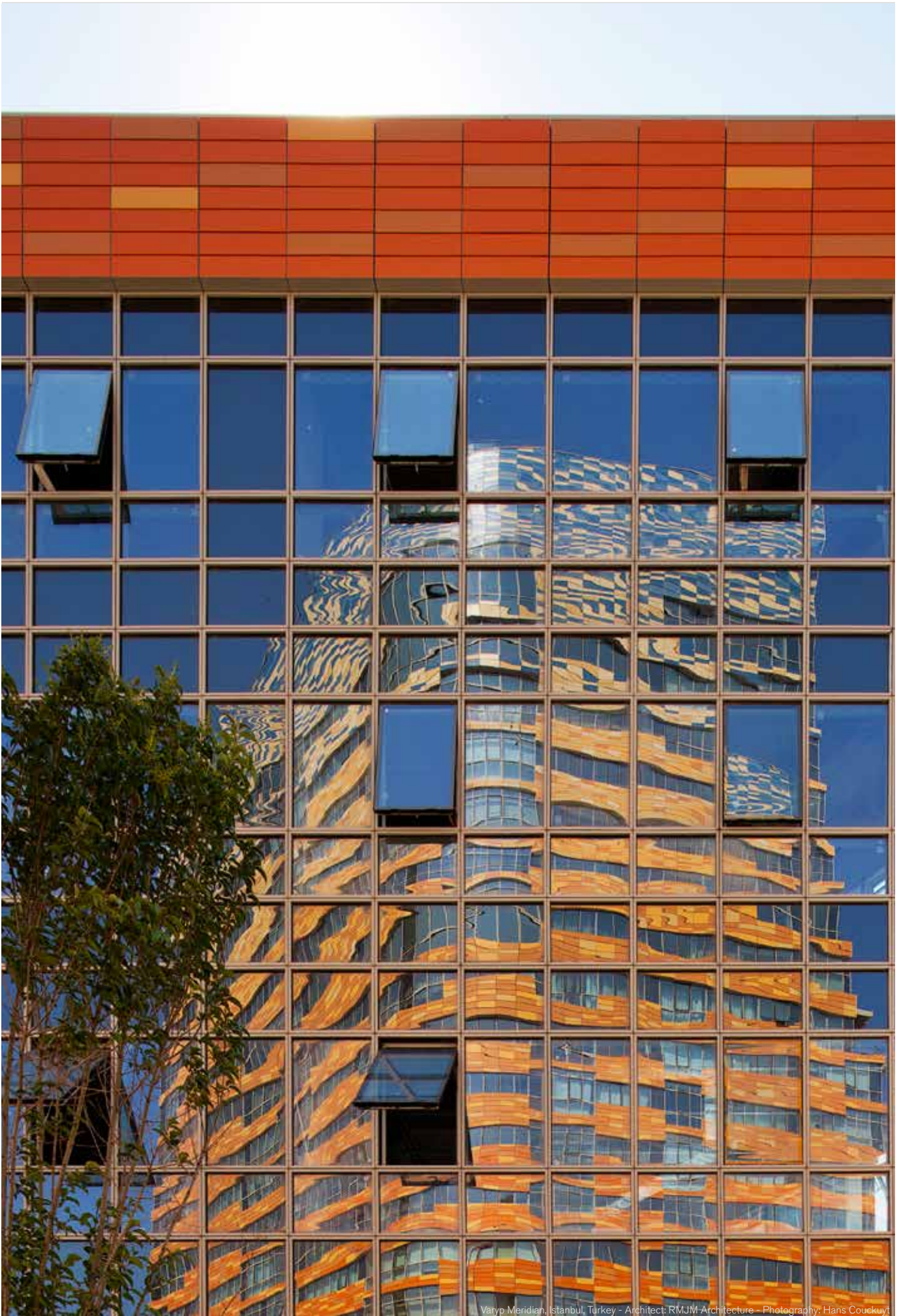

Varyp Meridian, Istanbul, Turkey - Architect: RMJM-Architecture - Photography: Hans Coukuyt

Elegance 52 IT

Integrated windows

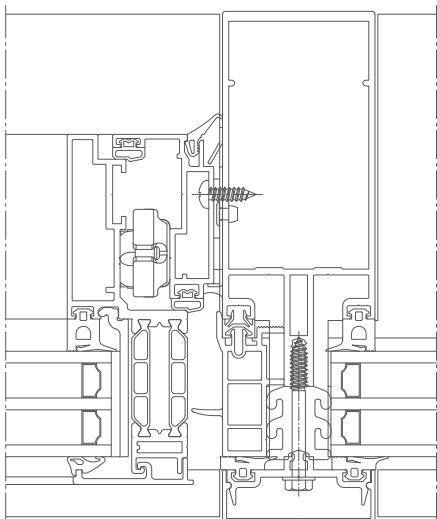
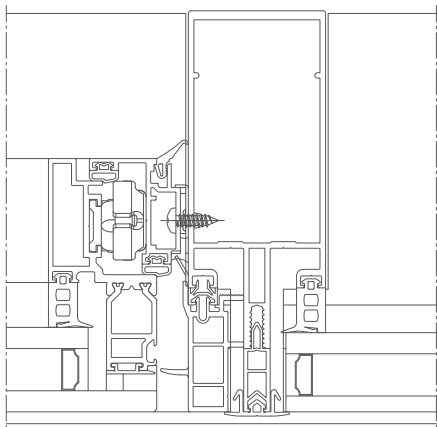
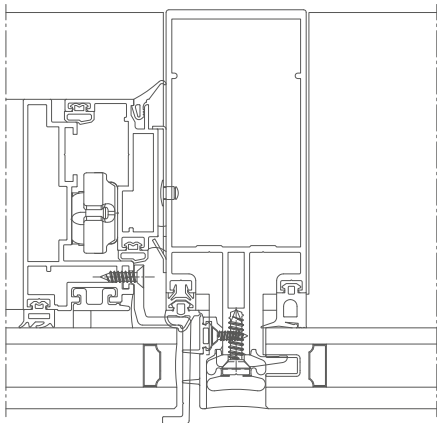

Elegance IT is an outward opening window-system, specifically designed with minimal visual aspect opening vents, for integration with Elegance 52 ST, HL, VL, SX and SGC.

- The complete range of Elegance 52 IT windows are available as a projected top-hung using dedicated vent profiles, or as a parallel opening where the same vent profile can also be used for larger top hung's.
- Motorised solutions are also available with discrete housing profiles.
- Two structurally glazed solutions are available in the Elegance 52 IT range, allowing stepped double glazed units to be bonded to a thermally broken vent (Elegance 5 IT S), or non-stepped vents to be bonded to a cold vent (Elegance 52 IT NS).
- 3M VHB tape can also be used instead of traditional structural sealants.
- In all cases the double glazed units are retained with security clips to ensure total safety.
- As an alternative structural glazing, the Elegance 52 IT window can also be traditionally glazed and externally beaded (Elegance 52 IT GB).

System performance

Airtightness	A4
Watertightness	RE1200
Wind resistance	1200
Impact resistance	I4 / E5



Elegance 52 / 85 GF

Glazed frame curtain walling

Elegance 52/85 GF is a semi-unitised system, with factory prepared externally beaded glazed frames secured into each aperture of the curtain wall for a picture framed appearance.

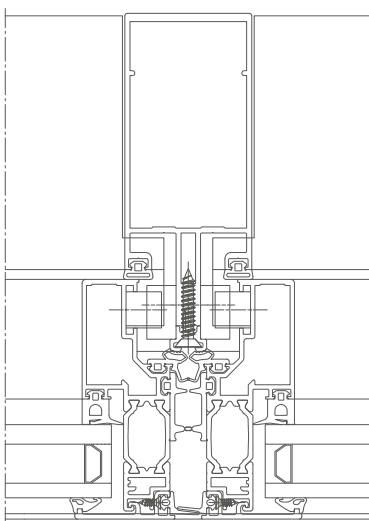
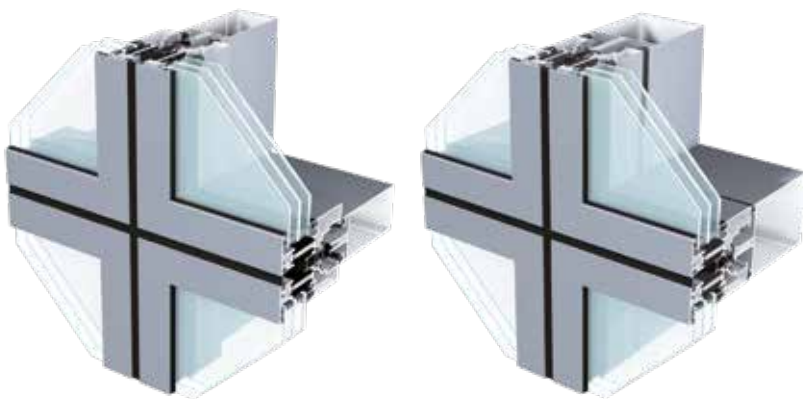

Elegance 52 GF

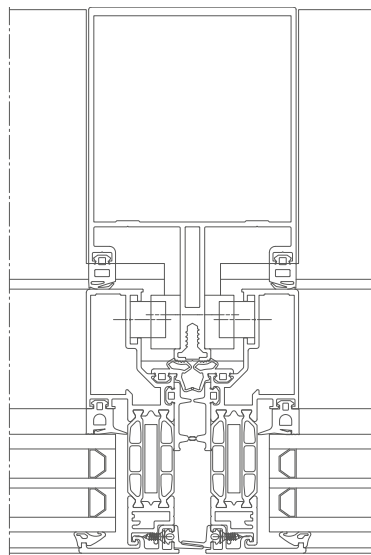

Elegance 85 GF

- Factory prepared beaded frames are used to rapidly glaze and weather tight the Elegance 52 curtain wall.
- The same frames can also be used with a dedicated range of 85mm mullion and transom profiles to create a hidden vent appearance when viewed from the inside outwards.
- Each frame can be permanently fixed to the curtain wall, or be fitted using friction stays for top-hung opening.
- All frames provide a uniform picture-frame external appearance with the opening part indistinguishable from the fixed parts.
- Using different thermal breaks and foam inserts, four thermal steps are available for the frames.
- Factory prepared frames ensure the highest level of workmanship is achieved.
- Integrated EPDM perimeter gaskets fitted to each frame in the factory ensure robust weather performance.

System performance

Airtightness	A4
Watertightness	RE1200
Wind resistance	2000
Impact resistance	I4 / E5



Matador Group HQ, Bratislava, Slovakia - Architect: Jančina architekti

Elegance 52 / 85 SG

Structurally glazed curtain wall system

Elegance 52/85 SG is a semi-unitised system, with factory prepared structurally glazed frames secured into each aperture of the curtain wall for a flush glazed appearance.

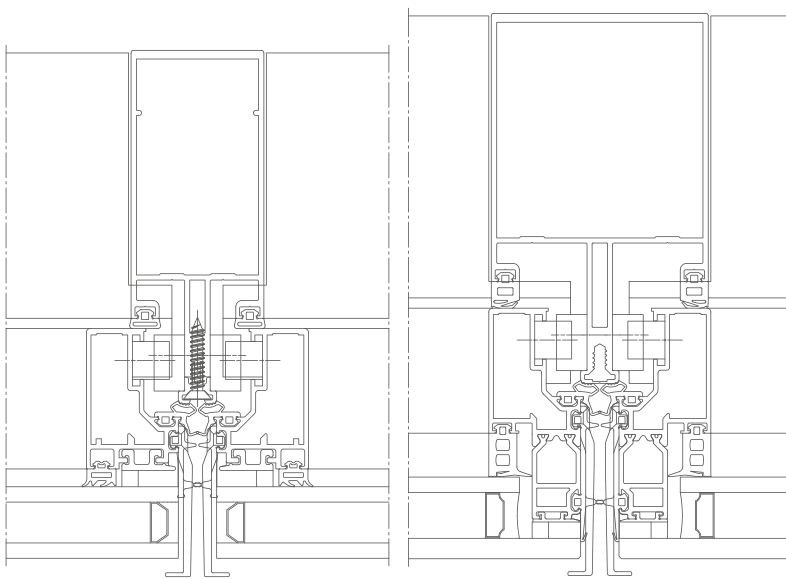

Elegance 52 SG NS

Elegance 85 SG S

- Factory prepared structurally glazed frames are used to rapidly glaze and weather tight the Elegance 52 curtain wall.
- The same frames can also be used with a dedicated range of 85 mm mullion and transom profiles to create a hidden vent appearance when viewed from the inside outwards.
- Each frame can be permanently fixed to the curtain wall, or be fitted using friction stays for top-hung opening.
- All frames provide a uniform external appearance with the opening part indistinguishable from the fixed parts.
- Different frames are available for stepped and non-stepped double glazed units.
- Factory prepared frames ensure the highest level of workmanship is achieved.
- Integrated EPDM perimeter gaskets fitted to each frame in the factory ensure robust weather performance.

System performance

Airtightness	A4
Watertightness	RE1200
Wind resistance	1600
Impact resistance	I4 / E2



Spine Tower, Istanbul, Turkey - Architect: 2design Group - Photography: Hans Couckuyt

Elegance 72

Unitised curtain walling

Elegance 72 is a unitised curtain walling system, combining both off-the-shelf solutions and project specific designs, each utilising the same common robust platform.

- Modular units are fully manufactured in the workshop, complete with all glazing units, spandrel panels, shading devices, fixing brackets, integrated windows and doors, for reduced labour costs, improved quality control and no weather delays.
- Installation of the modular units is considerably faster than traditional stick built curtain wall, reducing the on-site programme, whilst at the same time utilising less manpower.
- Cranes are used for lifting and positioning modules, promoting safer working practices as fixing takes place on the inside of the building.
- The need for external scaffolding is eliminated, which can benefit many inner city construction sites where access is restricted.
- The benefits of just-in-time deliveries can also be implemented for construction sites where storage space is limited

System performance

Airtightness	A4
Watertightness	RE1500
Wind resistance	2400
Impact resistance	E5

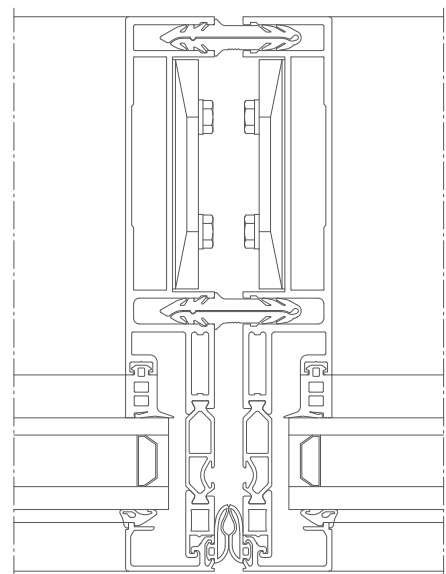

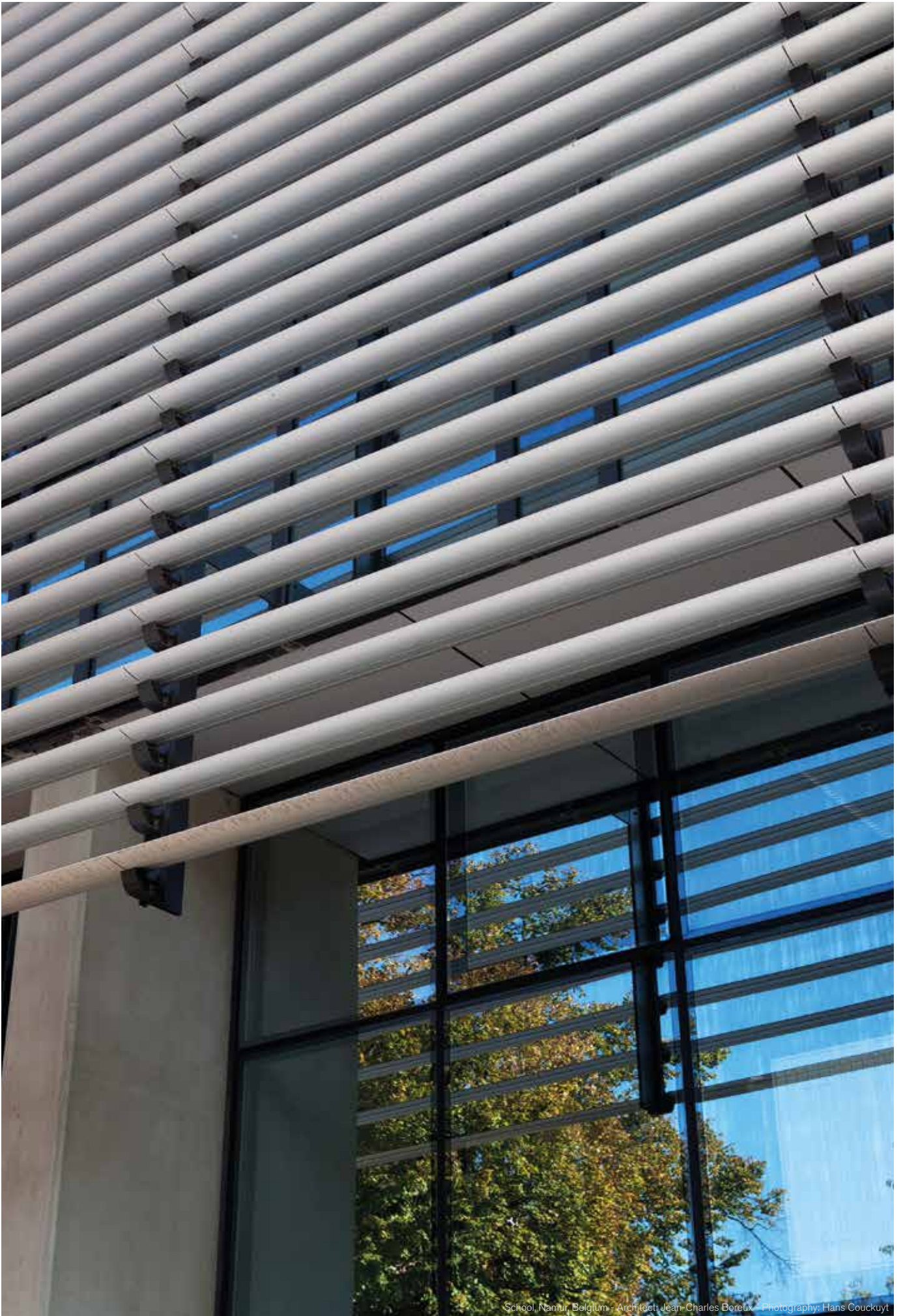

School, Namur, Belgium - Architect: Jean-Charles Boreux - Photography: Hans Couckuyt

Elegance 52 Solar control

The Elegance SC solar control range has been developed to compliment Elegance 52 curtain wall system and meet the ever increasing energy demands put on the building facade.



Eco Clip system has been developed to provide maximum shading to a facade, both in terms of area coverage and configuration options, whilst using simple profiles that are lightweight and inherently economic.

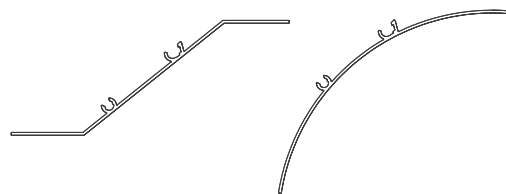

Aero Clip system has been developed to provide suited solutions for all applications with an emphasis on eye catching design.

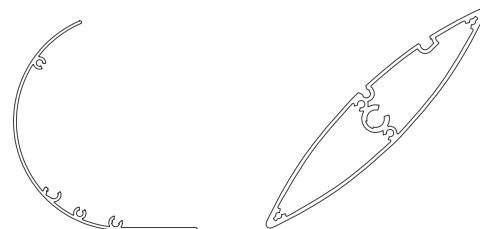

Side-arm system is a range of blade profiles that can be used to create any shading configuration.

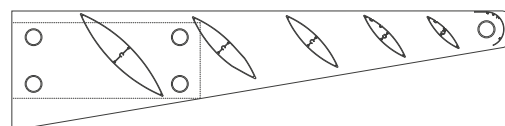



Building Systems keeps developing its systems and maintains the right to change this document as well as all technical data related without prior notice. Consult your local Building Systems office to receive the most recent information.

SAPA offers architects, specifiers, metal fabricators, investors and home-owners worldwide an extensive range of innovative, reliable and aesthetically pleasing aluminium systems for curtain walling, doors, windows and building integrated photovoltaics. SAPA is one of the largest suppliers of aluminium building systems in Europe and is part of the global aluminium company Hydro.

Aluminium is our business

Hydro Building Systems Belgium nv

- Industrielaan 17, BE-8810 Lichtervelde
T +32 (0)51 72 96 66 | F +32 (0)51 72 96 89
- Industriezone Roosveld 11, BE-3400 Landen
T +32 (0)11 69 03 11 | F +32 (0)11 83 20 04
- E info.hbs.be@hydro.com | www.sapabuildingsystem.com

part of

